

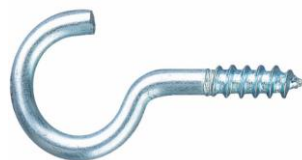

AL-RO



AL-HA



AL-HC



AL-ROB



AL-HAB



AL-HCB



AL-RE



HARM



HCRM



AL-PL



PA-CP

CHARACTERISTICS

Nails and bolts with operating principle by screwing or by nailed.

Easy installation.

Wood use.





















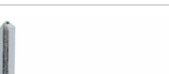

Types:

- Metal hook bolt, with thread
- Open metal eye bolt
- Closed metal eye bolt
- Flat head steel nails

BASE MATERIAL

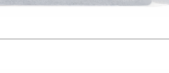

1. RANGE

ITEM	CODE	SIZES	PHOTO	COMPONENT	MATERIAL
1	AL-RO	2,6 x 17 x 10 ÷ 7,8 x 105 x 25		Metal hook bolt	
2	AL-HA	2,6 x 18 x 7 ÷ 6,9 x 89 x 35		Open metal eye bolt	
3	AL-HC	2,6 x 18 x 7 ÷ 6,9 x 89 x 35		Closed metal eye bolt	
4	AL-ROB	3,1 x 20 x 10 ÷ 4,4 x 46 x 17		Metal hook bolt	
5	AL-HAB	3,1 x 22 x 9 ÷ 4,4 x 39 x 15		Open metal eye bolt	
6	AL-HCB	3,1 x 22 x 9 ÷ 4,4 x 42 x 15		Closed metal eye bolt	
7	AL-RE	2 x 15 x 7 ÷ 4 x 80 x 16		Round steel hook	
8	HA-RM	M3 x 26 ÷ M8 x 60		Open metal eye bolt with metric thread	
9	HC-RM	M3 x 26 ÷ M12 x 75		Closed metal eye bolt with metric thread	
10	AL-PL	3 x 60 x 15 ÷ 5 x 120 x 30		Flat steel hook	
11	PA-CP	2,25 x 20 ÷ 3,4 x 80		Flat head nail	

2. INSTALLATION DATA

2.1 AL-RO

Hook bolt with thread



Properties



Steel



Zinc plated

Sizes

CODE	SIZE ($\varnothing d \times L1 \times L2$) [mm]	$\varnothing d$ [mm]	L1 [mm]	L2 [mm]	$\varnothing D$ [mm]	B [mm]
ALRO14025	2,6 x 17 x 10	2,6	17	10	2	10
ALRO16030	3,1 x 20 x 10	3,1	20	10	2,4	12
ALRO17040	3,5 x 29 x 13	3,5	29	13	2,7	17
ALRO18040	3,7 x 28 x 14	3,7	28	14	2,9	17
ALRO18050	3,7 x 37 x 15	3,7	37	15	2,9	22
ALRO19050	4,4 x 37 x 15	4,4	37	15	3,4	22
ALRO19060	4,4 x 46 x 17	4,4	46	17	3,4	28
ALRO19070	4,4 x 55 x 18	4,4	55	18	3,4	33
ALRO20060	5 x 44 x 20	5,0	44	20	3,9	26
ALRO20070	5 x 53 x 20	5,0	53	20	3,9	32
ALRO20080	5 x 63 x 21	5,0	63	21	3,9	38
ALRO21080	5,6 x 60 x 22	5,6	60	22	4,4	36
ALRO21090	5,6 x 70 x 22	5,6	70	22	4,4	42
ALRO22100	6 x 79 x 23	6,0	79	23	4,7	47
ALRO22110	6 x 86 x 23	6,0	86	23	4,7	52
ALRO22120	6 x 97 x 25	6,0	97	25	4,7	58
ALRO23130	7,8 x 105 x 25	7,8	105	25	5,8	63

DRAWING

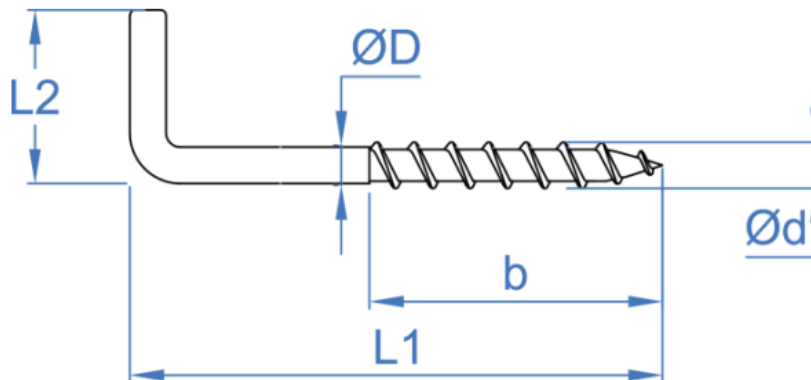

2.2 AL-HA

Open eye bolt

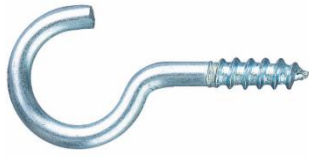

Properties



Steel

Zinc plated

Sizes

CODE	SIZE ($\varnothing d \times L1 \times b$) [mm]	$\varnothing D$ [mm]	L1 [mm]	b [mm]	L2 [mm]	$\varnothing d$ [mm]
ALHA14025	2,6 x 18 x 7	2,6	18	7	10	2,1
ALHA16030	3,1 x 22 x 9	3,1	22	9	12	2,4
ALHA17040	3,5 x 28 x 10	3,5	28	10	14	2,7
ALHA18040	4,1 x 30 x 10	4,1	30	10	15	3,2
ALHA18050	3,7 x 39 x 12	3,7	39	12	20	3,2
ALHA19050	4,4 x 35 x 12	4,4	35	12	18	3,4
ALHA19060	4,4 x 42 x 15	4,4	42	15	22	3,4
ALHA19070	4,4 x 44 x 15	4,4	44	15	24	3,4
ALHA20050	5 x 39 x 12	5	39	12	19	3,9
ALHA20060	5 x 41 x 12	5	41	12	21	3,9
ALHA20070	5 x 48 x 14	5	48	14	26	3,9
ALHA20080	5 x 54 x 18	5	54	18	30	3,9
ALHA21070	5,6 x 49 x 14	5,6	49	14	23	4,4
ALHA21080	5,6 x 54 x 14	5,6	54	14	28	4,4
ALHA21090	5,6 x 61 x 14	5,6	61	14	32	4,4
ALHA21100	5,6 x 66 x 18	5,6	66	18	37	4,4
ALHA22110	6 x 76 x 24	6	76	24	43	4,7
ALHA22120	6 x 81 x 29	6	81	29	48	4,7
ALHA23130	6,9 x 89 x 35	6,3	89	35	55	5,2

DRAWING

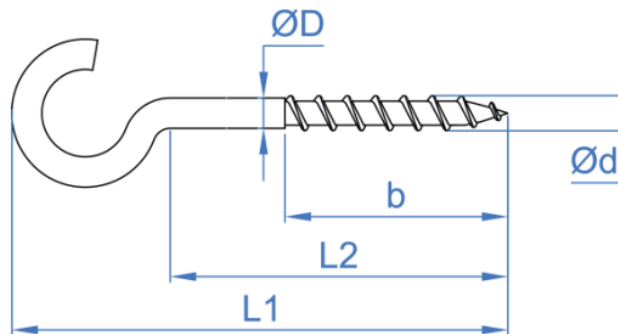

2.3 AL-HC

Closed eye bolt



Properties



Steel

Zinc plated

Sizes

CODE	SIZE ($\varnothing d \times L1 \times b$) [mm]	$\varnothing D$ [mm]	L1 [mm]	b [mm]	L2 [mm]	$\varnothing d$ [mm]
ALHC14025	2,6 x 18 x 7	2,6	18	7	10	2,1
ALHC16030	3,1 x 22 x 9	3,1	22	9	12	2,4
ALHC17040	3,5 x 26 x 10	3,5	26	10	14	2,7
ALHC18040	4,1 x 28 x 10	4,1	28	10	15	3,2
ALHC18050	4,1 x 34 x 12	4,1	34	12	20	3,2
ALHC19050	4,4 x 33 x 12	4,4	33	12	18	3,4
ALHC19060	4,4 x 39 x 15	4,4	39	15	22	3,4
ALHC19070	4,4 x 41 x 15	4,4	41	15	24	3,4
ALHC20050	5 x 35 x 12	5	35	12	19	3,9
ALHC20060	5 x 39 x 12	5	39	12	21	3,9
ALHC20070	5 x 44 x 14	5	44	14	26	3,9
ALHC20080	5 x 50 x 18	5	50	18	30	3,9
ALHC21070	5,6 x 43 x 14	5,6	43	14	23	4,4
ALHC21080	5,6 x 48 x 14	5,6	48	14	28	4,4
ALHC21090	5,6 x 56 x 14	5,6	56	14	32	4,4
ALHC21100	5,6 x 61 x 18	5,6	61	18	37	4,4
ALHC22110	6 x 69 x 24	6	69	24	43	4,7
ALHC22120	6 x 74 x 29	6	74	29	48	4,7
ALHC23130	6,9 x 82 x 35	6,3	82	35	55	5,2

DRAWING

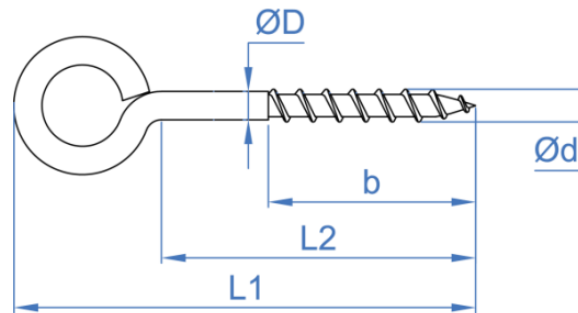

2.4 AL-ROB

Hook bolt with thread white



Properties



Steel



White painting

Sizes

CODE	SIZE ($\varnothing d \times L1 \times L2$) [mm]	$\varnothing d$ [mm]	L1 [mm]	L2 [mm]	B [mm]	$\varnothing D$ [mm]
ALROB16030	3,1 x 20 x 10	3,1	20,0	10,0	10,0	2,4
ALROB17040	3,5 x 29 x 13	3,5	29,0	13,0	13,0	2,7
ALROB18050	3,7 x 37 x 15	3,7	37,0	15,0	18,0	2,9
ALROB19060	4,4 x 46 x 17	4,4	46,0	17,0	24,0	3,4

DRAWING

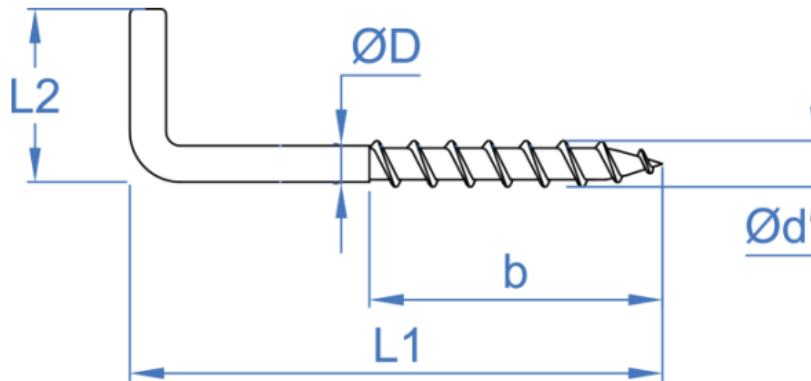

2.5 AL-HAB

Open eye bolt white



Properties



Steel



White painting

Sizes

CODE	SIZE ($\varnothing d \times L1 \times b$) [mm]	$\varnothing d$ [mm]	L1 [mm]	b [mm]	L2 [mm]	$\varnothing D$ [mm]
ALHAB16030	3,1 x 22 x 9	3,1	22,0	9,0	12,0	2,4
ALHAB17040	3,5 x 26 x 10	3,5	26,0	10,0	14,0	2,7
ALHAB18050	3,7 x 34 x 12	3,7	34,0	12,0	20,0	3,2
ALHAB19060	4,4 x 39 x 15	4,4	39,0	15,0	22,0	3,4

DRAWING

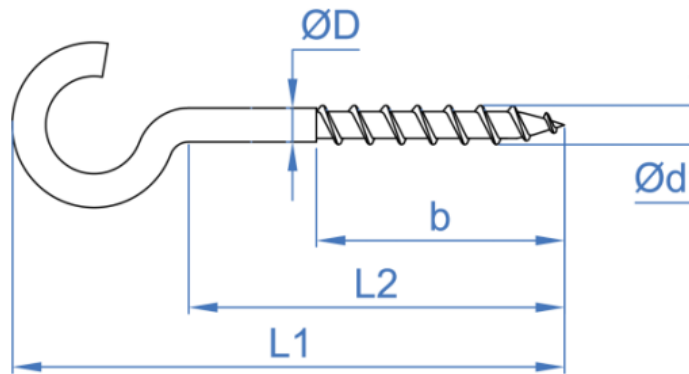

2.6 AL-HCB

Closed eye bolt white



Properties



Steel



White painting

Sizes

CODE	SIZE ($\varnothing d \times L1 \times b$) [mm]	$\varnothing d$ [mm]	L1 [mm]	b [mm]	L2 [mm]	$\varnothing D$ [mm]
ALHCB16030	3,1 x 22 x 9	3,1	22,0	9,0	12,0	2,4
ALHCB17040	3,5 x 28 x 10	3,5	28,0	10,0	14,0	2,7
ALHCB18050	4,1 x 39 x 12	4,1	39,0	12,0	20,0	3,2
ALHCB19060	4,4 x 42 x 15	4,4	42,0	15,0	22,0	3,4

DRAWING

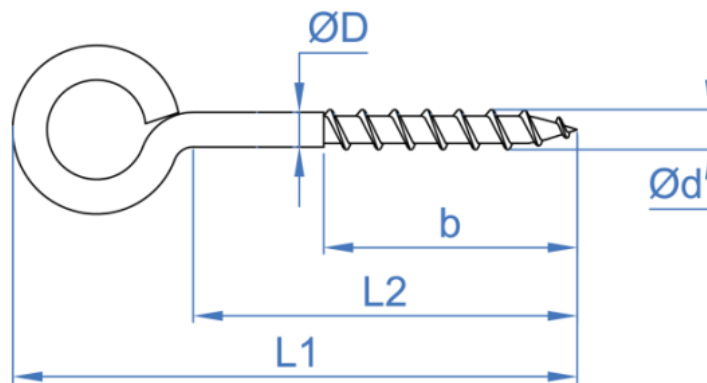

2.7 AL-RE

Round steel hook



Properties



Steel

Zinc plated

Sizes

CODE	SIZE ($\varnothing d \times L1 \times L2$) [mm]	$\varnothing D$ [mm]	L1 [mm]	L2 [mm]	E [mm]
ALRE20015	2 x 15 x 7	2,0	15,0	7,0	1,2
ALRE25020	2,5 x 20 x 12	2,5	20,0	12,0	1,5
ALRE25025	2,5 x 25 x 12	2,5	25,0	12,0	1,5
ALRE25030	2,5 x 30 x 12	2,5	30,0	12,0	1,5
ALRE35040	3,5 x 40 x 14	3,5	40,0	14,0	2,0
ALRE35050	3,5 x 50 x 14	3,5	50,0	14,0	2,0
ALRE40060	4 x 60 x 16	4,0	60,0	16,0	3,2
ALRE40070	4 x 70 x 16	4,0	70,0	16,0	3,2
ALRE40080	4 x 80 x 16	4,0	80,0	16,0	3,2

DRAWING

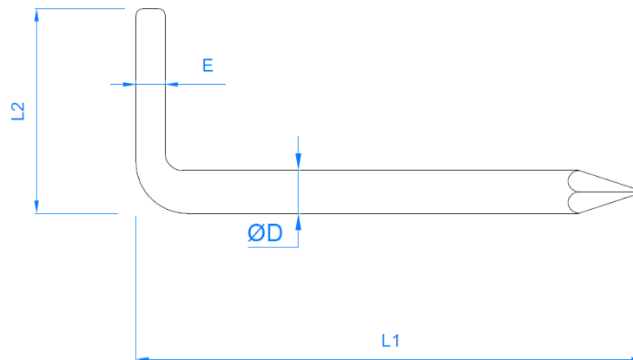

2.8 HA-RM

Open eye bolt with metric thread



Properties



Steel



Zinc plated

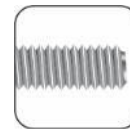

Metric thread

Sizes

CODE	SIZES	ØM	ØA [mm]	L [mm]	B [mm]	F [mm]	Nut	Maximum load [kg]
HARM03026	M3 x 26	M3	14	42	24	7,0	M3	8
HARM04035	M4 x 35	M4	17	54	30	7,0	M4	25
HARM05037	M5 x 37	M5	21	65	37	10,0	M5	48
HARM06050	M6 x 50	M6	25	80	50	12,0	M6	59
HARM08060	M8 x 60	M8	30	98	60	9,5	M8	100

DRAWING

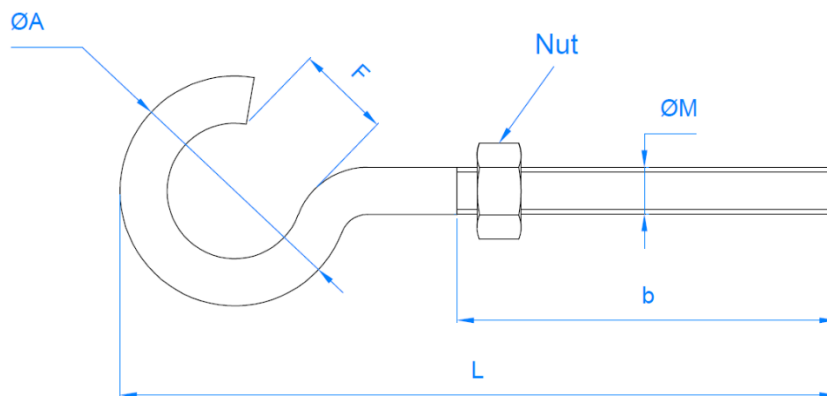

2.9 HC-RM

Closed eye bolt with metric thread



Properties

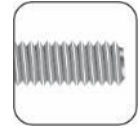

Steel

Zinc plated

Metric thread

Sizes

CODE	SIZES	ØD [mm]	A [mm]	ØB [mm]	R [mm]	L [mm]	Nut	Maximum load [kg]
HCRM03026	M3 x 26	M3	2,60	9	26	40	M3	8
HCRM04035	M4 x 35	M4	3,42	9	35	54	M4	25
HCRM05037	M5 x 37	M5	4,32	10	37	65	M5	48
HCRM06050	M6 x 50	M6	5,20	12	50	80	M6	59
HCRM08060	M8 x 60	M8	7,00	16	60	95	M8	100
HCRM10065	M10 x 65	M10	8,85	25	65	113	M10	192
HCRM12075	M12 x 75	M12	10,65	30	75	140	M12	326

DRAWING

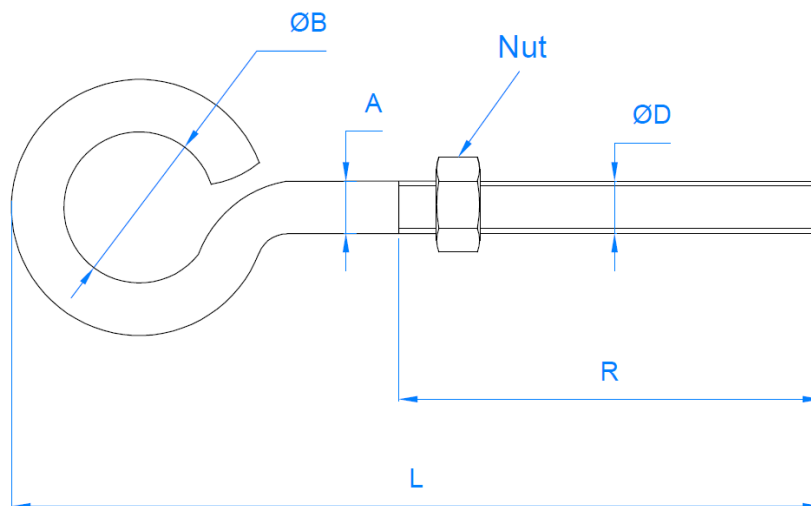

2.10 AL-PL

Flat steel hook

Properties



Steel



Zinc plated



Sizes

CODE	SIZES	MARK	∅A	B [mm]	C [mm]	L [mm]	D [mm]	D1 [mm]
ALPL45060	3 x 60 x 15	4	15	3	5,5	60	5	4
ALPL45080	4 x 80 x 20	5	20	4	7,0	80	7	4
ALPL45100	4 x 100 x 25	6	25	4	8,5	100	7	4
ALPL50120	5 x 120 x 30	7	30	5	10,0	120	8	6

DRAWING

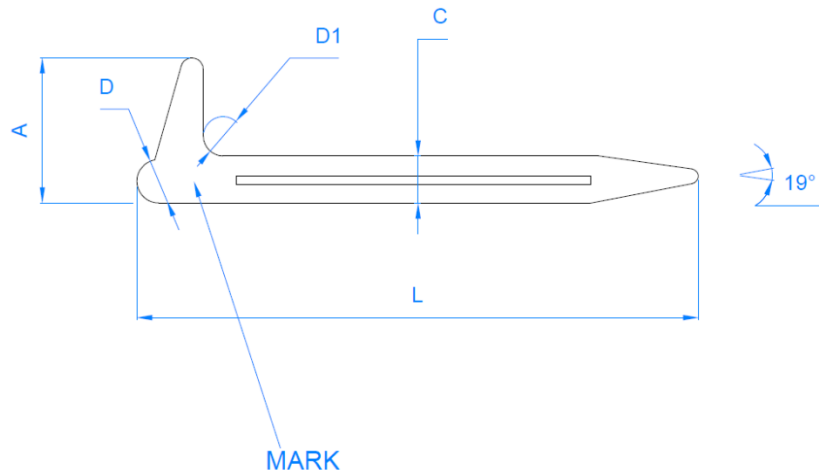

*For use in concrete, it is recommended to pre-drill ∅ 5, ∅ 7, ∅ 8, ∅ 10 respectively

2.11 PA-CP

Flat head nail



Properties



Steel



Zinc plated

Sizes

CODE	ØD [mm]	L1 [mm]	L2 [mm]
PACP22520	2,25	20	5,0
PACP22525	2,25	25	5,0
PACP22530	2,25	30	5,0
PACP25040	2,5	40	5,5
PACP25050	2,5	50	5,0
PACP29050	2,9	50	6,5
PACP29060	2,9	60	6,5
PACP29070	2,9	70	6,5
PACP34030	3,4	30	7,5
PACP34040	3,4	40	7,5
PACP34050	3,4	50	7,5
PACP34060	3,4	60	7,5
PACP34070	3,4	70	7,5
PACP34080	3,4	80	7,5

DRAWING

